

RUČKICE I VJEŠALICE

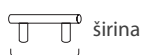

Kotiranje i šifre proizvoda

RUČKE



širina



razmak vijaka



visina



širina



količina u pakiranju

GUMBI



promjer



visina



količina u pakiranju

UKOPNE RUČKE



vanjske dimenzije



unutarne dimenzije



dubina



razmak vijaka



količina

VJEŠALICE



visina



razmak



širina



dubina



količina

ŠIFRE:

Ručka = Artikl + razmak + površinska obrada

Gumb = Artikl + površinska obrada

Vješalica = Artikl + površinska obrada

Ukopna ručka = Artikl + površinska obrada

„FO” ručke i vješalice imaju jedinstvenu šifru za površinsku obradu (vidi u tablici artikl)

Površinska obrada

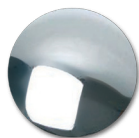

KR
krom



MNIG
mat nikal



MNI
mat nikal



MKR
mat krom



MKRG
mat krom

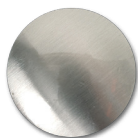

SAT
saten



MZL
mat zlatna



BE
bijela

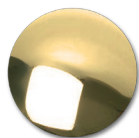

ZL
zlatna



INOX
inoks



CR
crna







CRM
crna mat



EL
eloksirano

Ručke







Artikl					
RH70055	136	128	27	8	40
	167	160	27	8	40
	199	192	27	8	20
	327	320	27	8	20

POVRŠINSKE OBRAD

-  **MKR** MAT KROM
-  **MS** MAT SIVA - GRAFIT



Artikl					
RH71121	138	128	27	10	25
	170	160	27	10	25

POVRŠINSKE OBRAD

-  **MC** MAT CRNA

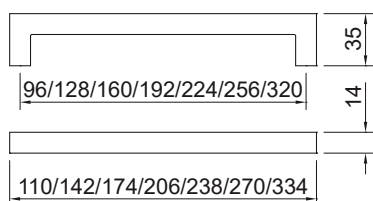

Artikl	Naziv
FO7652300	Ručkica E064-160 INOX
FO7652310	Ručkica E064-192, INOX
FO7652330	Ručkica E064-256, INOX
FO7652340	Ručkica E064-320, INOX

POVRŠINSKE OBRAD

-  **INOX**

Ručke



Artikl					
RH71016	114	96	28	9	25
	152	128	28	9	25
	190	160	28	9	25
	226	192	28	9	25
	258	224	28	9	25

POVRŠINSKE OBRADE

- BSN** BRUŠEN SATEN NIKL
- MC** MAT CRNA
- MKR** MAT KROM

* Samo MKR

Zamjena za E081 ručku



Artikl					
RL2226	227	192	28	-	20

POVRŠINSKE OBRADE

- MKR** MAT KROM
- C** CRNA
- MNI** MAT NIKL

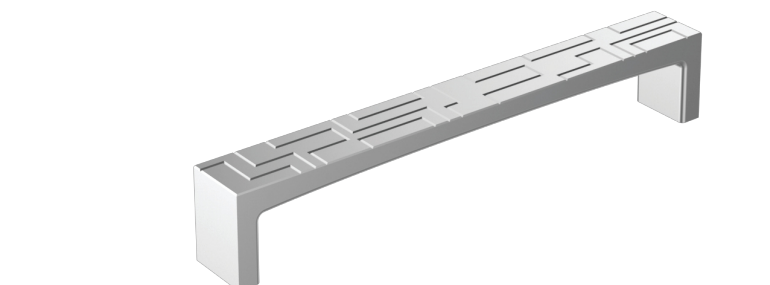

Artikl					
RL2439	164	160	29	-	20

POVRŠINSKE OBRADE

- MKR** MAT KROM



Artikl					
RH71004	168	160	29	25	50
	200	192	29	25	50
	232	224	29	25	25
	328	320	29	25	25

POVRŠINSKE OBRADÉ

MKR MAT KROM



Artikl					
RH7230	137	128	32	8	50

POVRŠINSKE OBRADÉ

BN BRUŠEN NIKL



Artikl					
RH71446	171	160	30	10	25

POVRŠINSKE OBRADÉ

BSN BRUŠEN SATEN NIKL

Ručke



Artikl					
RH71013	150	128	30	18	50
	180	160	30	18	50
	214	192	30	18	50

POVRŠINSKE OBRADJE

- MKR** MAT KROM

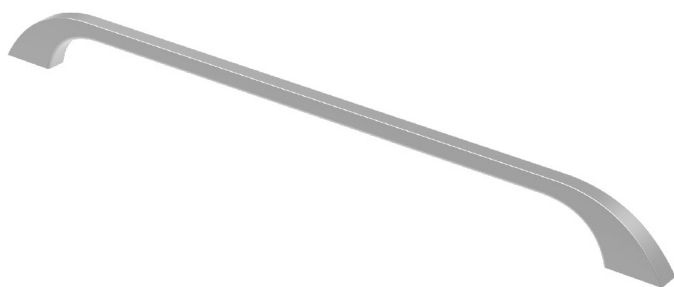

Artikl					
RL2455	356	320	30	-	20

POVRŠINSKE OBRADJE

- MKR** MAT KROM
- C** CRNA
- KR** KROM
- MNI** MAT NIKL



Artikl					
RL2457	195	160	30	-	20

POVRŠINSKE OBRADJE

- MKR** MAT KROM
- C** CRNA
- KR** KROM
- MNI** MAT NIKL

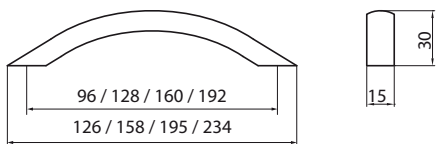

Artikl	Naziv
FO7653200	Ručkica A021-96 Aluminij
FO7653210	Ručkica A021-128 Aluminij
FO7653220	Ručkica A021-160 Aluminij
FO7653230	Ručkica A021-192 Aluminij

POVRŠINSKE OBRAD

● **AL ALUMINIJ**



Artikl					
RH70701	106	96	24	9	100
	148	128	24	9	50

POVRŠINSKE OBRAD

● **MKR MAT KROM**

Zamjena za E002 ručku

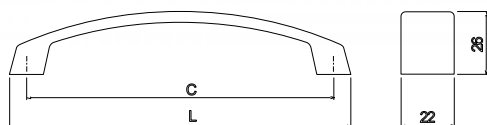

Artikl	Naziv
THR61-128IN	RUČKICA 61 128mm - inox
THR61-160IN	RUČKICA 61 160mm - inox
THR61-192IN	RUČKICA 61 192mm - inox
THR61-256IN	RUČKICA 61 256mm - inox
THR61-320IN	RUČKICA 61 320mm - inox

POVRŠINSKE OBRAD

● **IN INOX**

Ručke



Artikl					
RH71267	260	224	28	15	25
	196	160	26	14	30

POVRŠINSKE OBRAD

- BSN** BRUŠEN SATEN NIKL
- MKR** MAT KROM

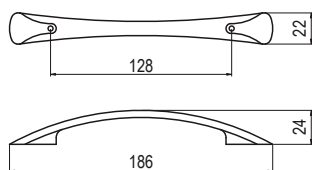

Artikl	Naziv
FO7650490	Ručkice E008-128 KROM
FO7650493	Ručkice E008-128 MKR

POVRŠINSKE OBRAD

- KR** KROM
- MKR** MAT KROM

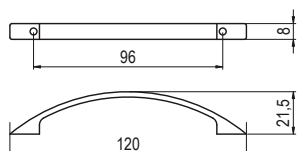



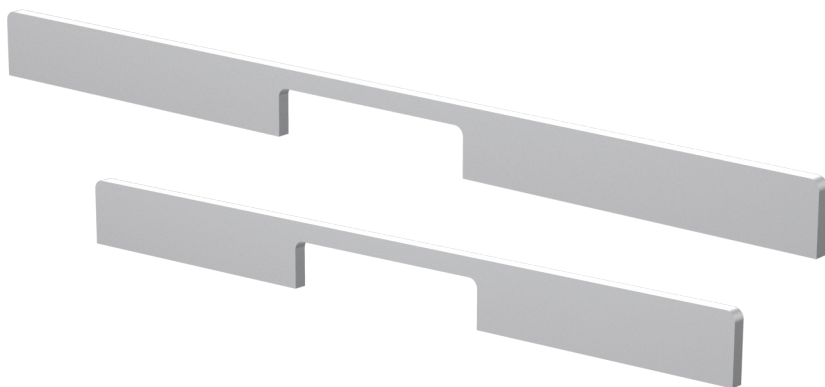

Artikl	Naziv
FO7601375	Ručkica T 250--096 mat krom

POVRŠINSKE OBRAD

- MKR** MAT KROM



Artikl					
RL2479	284	224	35	7	10
	380	320	35	7	10
	476	416	35	7	10
	572	512	35	7	10

POVRŠINSKE OBRADJE

 **AL ALUMINIJ**

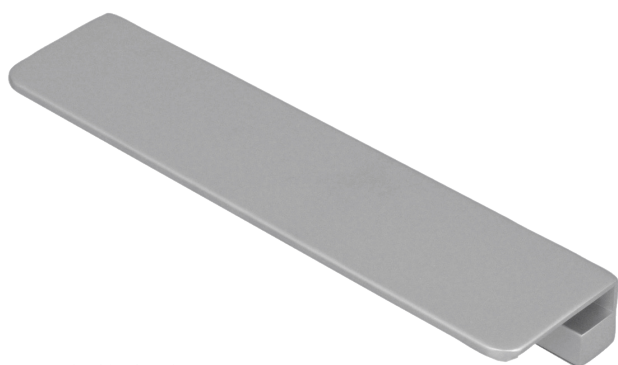

Artikl	Naziv
FO7653060	Ručkica A016-096 ALU
FO7653070	Ručkica A016-128 ALU
FO7653090	Ručkica A016-192 ALU

POVRŠINSKE OBRADJE

 **AL ALUMINIJ**

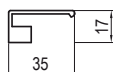
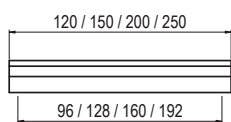

Ručke



Artikl					
RH12	188	128	32	12	50
	220	160	32	12	50
	252	192	32	12	50
	284	224	32	12	50
	348	288	32	12	50
	380	320	32	12	50

POVRŠINSKE OBRADE

SS SATEN ČETKAN



Artikl					
RH72278	168	128	33	14	25
	232	192	33	14	25

POVRŠINSKE OBRADE

MC MAT CRNA

SS SATEN ČETKAN

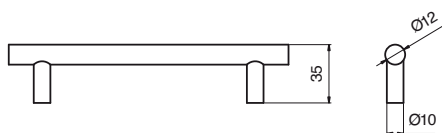

Artikl	Naziv
FO7650876	RUČKICA E037-096 NIKL
FO7650880	RUČKICA E037-128 NIKL
FO7650890	RUČKICA E037-160 NIKL
FO7650892	RUČKICA E037-192 NIKL
FO7650897	RUČKICA E037-256 NIKL
FO7650900	RUČKICA E037-288 NIKL
FO7650905	RUČKICA E037-320 NIKL
FO7650915	RUČKICA E037-384 NIKL
FO7650920	RUČKICA E037-448 NIKL
FO7650930	RUČKICA E037-560 NIKL
FO7650940	RUČKICA E037-660 NIKL
FO7650950	RUČKICA E037-760 NIKL

POVRŠINSKE OBRADE

NI NIKL

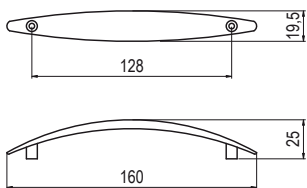
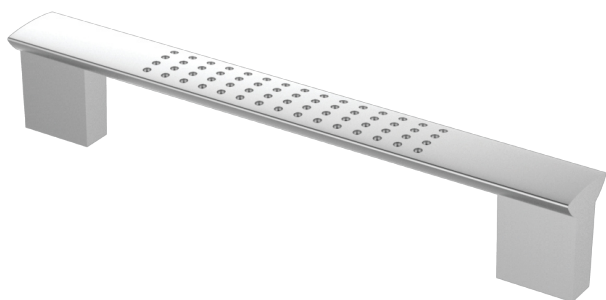
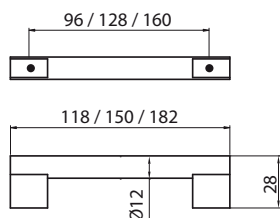
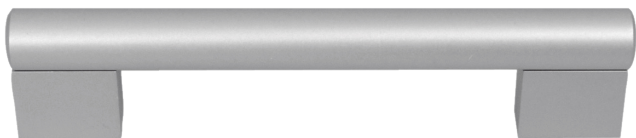

Artikl	Naziv
FO7653030	Ručkica A015-096 ALU
FO7653040	Ručkica A015-128 ALU
FO7653050	Ručkica A015-160 ALU

POVRŠINSKE OBRADJE

● **AL ALUMINIJ**

Artikl					
RL2294	143	128	26	13	20

POVRŠINSKE OBRADJE

● **MKR MAT KROM**

Artikl	Naziv
FO7610010	Ručkica T255-128 mat krom

POVRŠINSKE OBRADJE

● **MKR MAT KROM**

Ručke

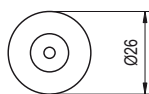

Artikl	Naziv
FO7601389	Ručkica T 252-28 krom
FO7601390	Ručkica T 252-28 mat krom
FO7601393	Ručkica T 252-28 mat nikl



POVRŠINSKE OBRADJE

-  **KR** KROM
-  **MKR** MAT KROM
-  **MNI** MAT NIKL



Artikl	Naziv
FO7650560	Ručkice E013- 032 KROM
FO7650561	Ručkice E013- 032 NIKL

POVRŠINSKE OBRADJE

-  **KR** KROM
-  **NI** NIKL

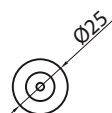

Artikl	Naziv
FO7653190	Ručkica A020-025 ALU

POVRŠINSKE OBRADJE

-  **AL** ALUMINIJ

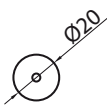



Artikl	Naziv
FO7653170	Ručkica A019-020 ALU

POVRŠINSKE OBRADJE

● **AL** ALUMINIJ



Artikl			
RH7015	27	23	80

POVRŠINSKE OBRADJE

● **MKR** MAT KROM

● **C** CRNA

Ručke



Artikl	Naziv
THRB224ALU	Ručkica B224 - alu
THRB224B	Ručkica B224 - bijela
THRB224C	Ručkica B224 - crna

POVRŠINSKE OBRADJE

-  **AL** ALUMINIJ
-  **C** CRNA
-  **B** BIJELA

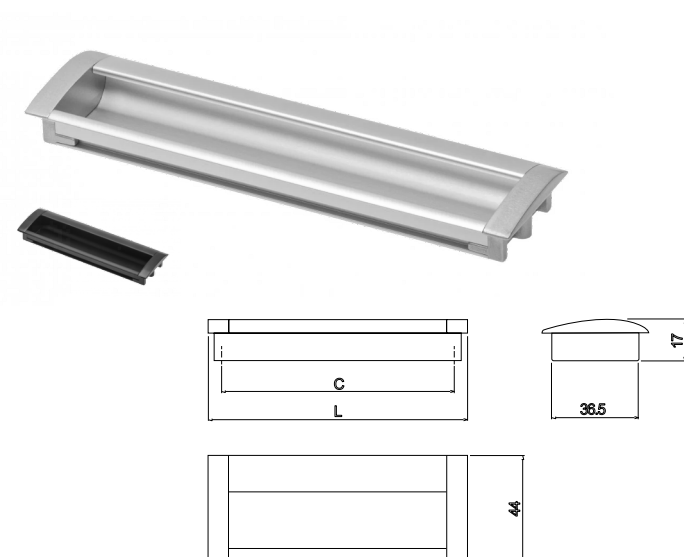

Artikl	Naziv
THRU326-128ALU	RUČKICA UKOPNA 326 128mm - alu
THRU326-128C	RUČKICA UKOPNA 326 128mm - crna
THRU326-160ALU	RUČKICA UKOPNA 326 160mm - alu
THRU326-160C	RUČKICA UKOPNA 326 160mm - crna

POVRŠINSKE OBRADJE

-  **AL** ALUMINIJ
-  **C** CRNA

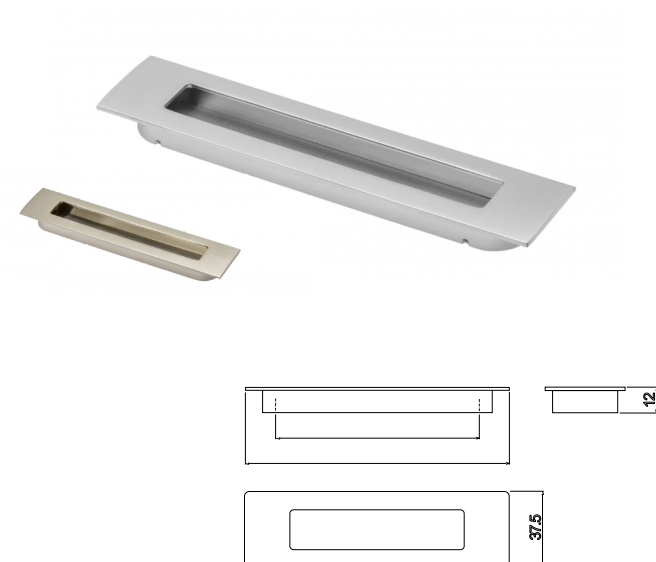

Artikl	Naziv
THRU306-128ALU	RUČKICA UKOPNA 306 128mm - alu
THRU306-128INOX	RUČKICA UKOPNA 306 128mm - inox
THRU306-160ALU	RUČKICA UKOPNA 306 160mm - alu
THRU306-160INOX	RUČKICA UKOPNA 306 160mm - inox

POVRŠINSKE OBRADJE

-  **AL** ALUMINIJ
-  **IN** INOX

Ručke



Artikl					
RH73173	74	64	20	31	35

POVRŠINSKE OBRADE

AM ANTIK MIJED



Artikl					
RH72503	128	96	32	15	35

POVRŠINSKE OBRADE

AM ANTIK MIJED

AS ANTIK SREBRNA





Artikl			
RH75033	26	28	50

POVRŠINSKE OBRADE

AM ANTIK MIJED

AS ANTIK SREBRNA





Artikl			
RL2207	30	22	20

POVRŠINSKE OBRAD

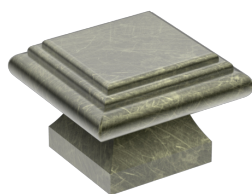
 **PAT** PATINA (STARO ZLATO)







Artikl			
RL2365	35	24	20

POVRŠINSKE OBRAD

 **PAT** PATINA (STARO ZLATO)







Artikl					
RL2341	127	96	29	12	20

POVRŠINSKE OBRAD

 **PAT** PATINA (STARO ZLATO)

Ručke



Artikl					
RL2321	167	128	22	13	20

POVRŠINSKE OBRAD

 **PAT** PATINA (STARO ZLATO)

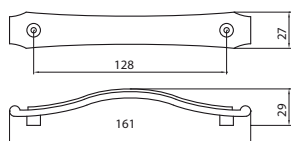

Artikl	Naziv
FO7551642	RUČKICA 628-128 FIRENZE PATINAS
FO7551643	RUČKICA 628-96 FIRENZE PATINAS

POVRŠINSKE OBRAD

 **PAT** PATINA (STARO ZLATO)

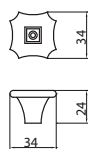

Artikl	Naziv
FO7551645	RUČKICA 628-000 FIRENZE PATINAS

POVRŠINSKE OBRAD

 **PAT** PATINA (STARO ZLATO)



Artikl					
RL2403	195	-	17	34	10
	295	-	17	34	10
	395	-	17	34	10
	495	-	17	34	10
	595	-	17	34	10
	695	-	17	34	10
	795	-	17	34	10
	895	-	17	34	10

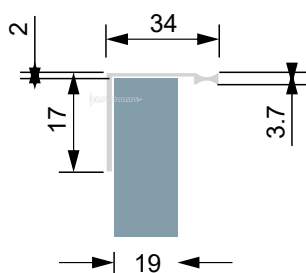
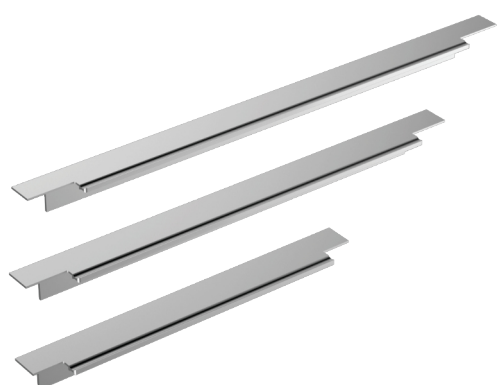

POVRŠINSKE OBRADJE

AL ALUMINIJ

Artikl	Naziv
THP22-296ALU	RUČKICA P22 296/18 ALU
THP22-296MC	RUČKICA P22 296/18 MAT CRNA
THP22-396ALU	RUČKICA P22 396/18 ALU
THP22-396MC	RUČKICA P22 396/18 MAT CRNA
THP22-496ALU	RUČKICA P22 496/18 ALU
THP22-496MC	RUČKICA P22 496/18 MAT CRNA
THP22-596ALU	RUČKICA P22 256/596/18 ALU
THP22-596MC	RUČKICA P22 596/18 MAT CRNA
THP22-796ALU	RUČKICA P22 796/18 ALU
THP22-796MC	RUČKICA P22 796/18 MAT CRNA

POVRŠINSKE OBRADJE

AL ALUMINIJ

C CRNA

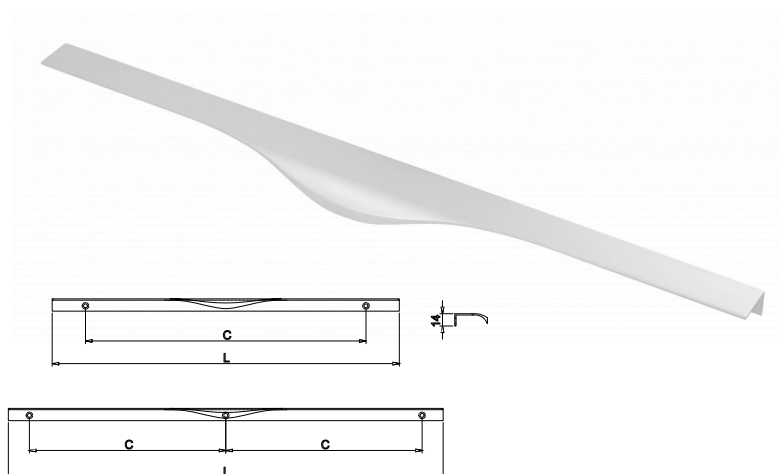

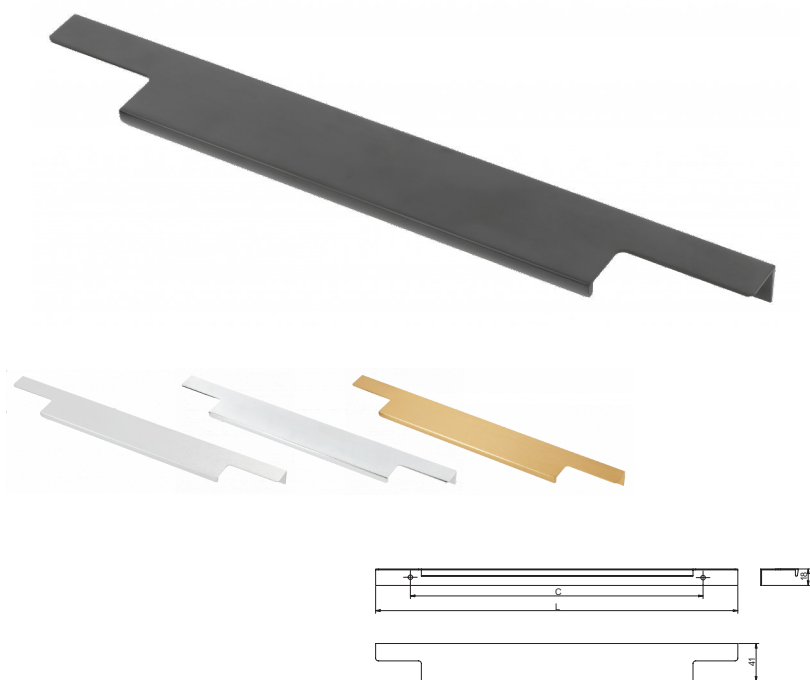

Artikl	Naziv
THP21-296ALU	RUČKICA P21 296/18 ALU
THP21-396ALU	RUČKICA P21 396/18 ALU
THP21-496ALU	RUČKICA P21 496/18 ALU
THP21-596ALU	RUČKICA P21 596/18 ALU
THP21-796ALU	RUČKICA P21 796/18 ALU
THP21-296KR	RUČKICA P21 296/18 KROM
THP21-396KR	RUČKICA P21 396/18 KROM
THP21-496KR	RUČKICA P21 496/18 KROM
THP21-596KR	RUČKICA P21 596/18 KROM
THP21-796KR	RUČKICA P21 796/18 KROM
THP21-296MC	RUČKICA P21 296/18 MAT CRNA
THP21-396MC	RUČKICA P21 396/18 MAT CRNA
THP21-496MC	RUČKICA P21 496/18 MAT CRNA
THP21-596MC	RUČKICA P21 596/18 MAT CRNA
THP21-796MC	RUČKICA P21 796/18 MAT CRNA
THP21-296ZL	RUČKICA P21 296/18 BRUŠENO ZLATO
THP21-396ZL	RUČKICA P21 396/18 BRUŠENO ZLATO
THP21-496ZL	RUČKICA P21 496/18 BRUŠENO ZLATO
THP21-596ZL	RUČKICA P21 596/18 BRUŠENO ZLATO
THP21-796ZL	RUČKICA P21 796/18 BRUŠENO ZLATO

POVRŠINSKE OBRAD

- AL** ALUMINIJ
- C** CRNA
- KR** KROM
- ZL** BRUŠENO ZLATO

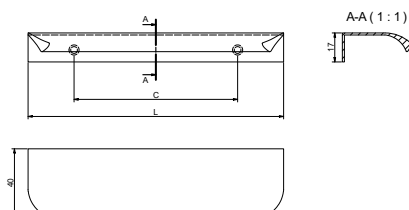
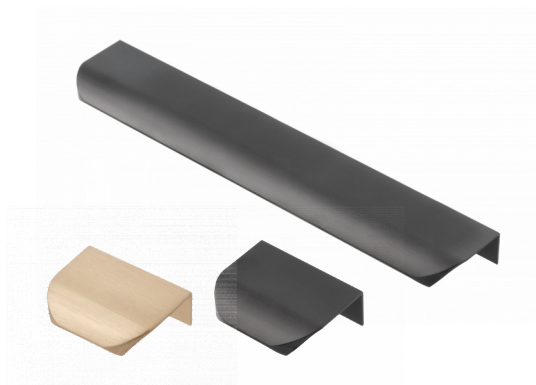

Artikl	Naziv
THP23-32BZ	Ručkica P23 32mm, brušeno zlato
THP23-32C	Ručkica P23 32mm, crna
THP23-96BZ	Ručkica P23 96mm, brušeno zlato
THP23-96C	Ručkica P23 96mm, crna
THP23-192BZ	Ručkica P23 192mm, brušeno zlato
THP23-192C	Ručkica P23 192mm, crna

POVRŠINSKE OBRAD

- C** CRNA
- ZL** BRUŠENO ZLATO

Profili

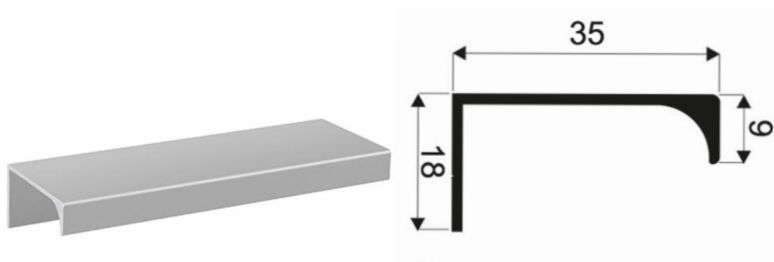

Artikl	Naziv
SVG8063000	Profilirana ručkica 806, ALU (3 m), 18x35

POVRŠINSKE OBRADJE

- **AL** ALUMINIJ



Artikl	Naziv
THL0243	RUČKICA L0243 (L=3,5m) - ALU
THL0243C	RUČKICA L0243 (L=3,5m) - CRNA

POVRŠINSKE OBRADJE

- **AL** ALUMINIJ
- **C** CRNA

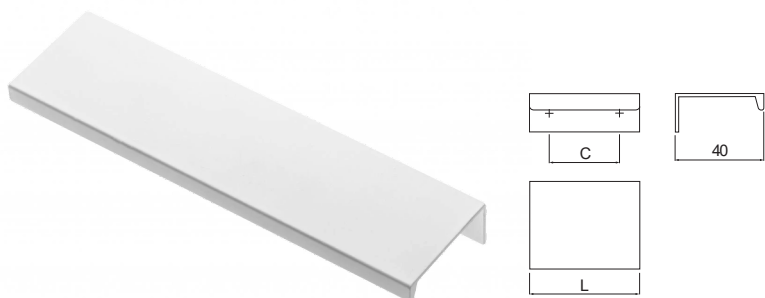

Artikl	Naziv
THP08-3500ALU	Ručkica Profil08 3500mm - alu
THP08-3500C	Ručkica Profil08 3500mm - crna

POVRŠINSKE OBRADJE

- **AL** ALUMINIJ
- **C** CRNA

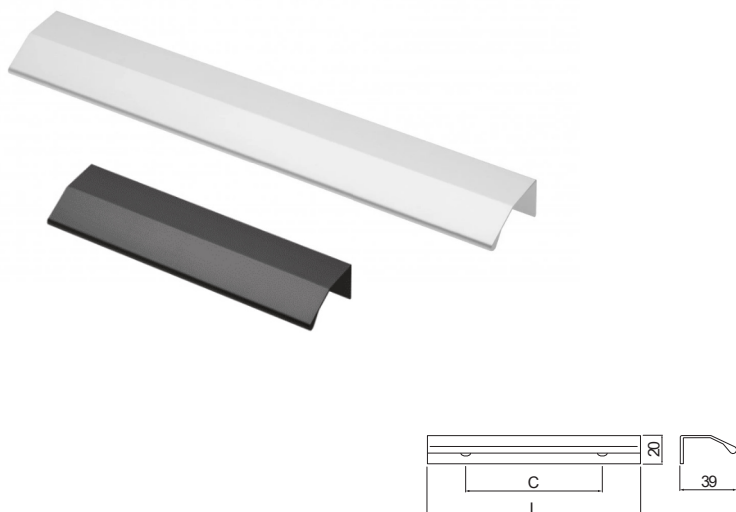

Artikl	Naziv
THP09-3500ALU	RUČKICA PROFIL09 3500mm - alu
THP09-3500C	RUČKICA PROFIL09 3500mm - crna

POVRŠINSKE OBRADJE

- **AL** ALUMINIJ
- **C** CRNA

Vješalice

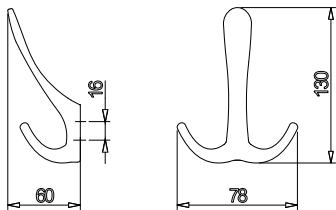

Artikl	Naziv
THV003C	Vješalica 003, crna
THV003KR	Vješalica 003, krom
THV003IN	Vješalica 003, INOX

POVRŠINSKE OBRADJE

-  **C** CRNA
-  **KR** KROM
-  **IN** INOX

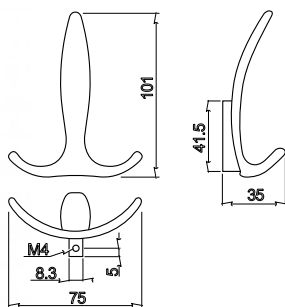



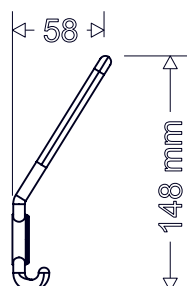

Artikl	Naziv
THV018C	Vješalica 018, crna
THV018KR	Vješalica 018, krom
THV018MKR	Vješalica 018, mat krom
THV018SAT	Vješalica 018, saten

POVRŠINSKE OBRADJE

-  **MKR** MAT KROM
-  **C** CRNA
-  **KR** KROM
-  **SAT** SATEN



Artikl					
VL7003	148	-	50	58	20

POVRŠINSKE OBRADJE

-  **MKR** MAT KROM
-  **C** CRNA

Vješalice



Artikl					
OH28101	132	20	75	77	30

POVRŠINSKE OBRADE

MKR MAT KROM



Artikl					
OH28105	90	14	24	63	50

POVRŠINSKE OBRADE

MKR MAT KROM



Artikl	Naziv
OH28109MKR	Vješalica 28109 mat krom
TH28109C	Vješalica 28109, Crna

POVRŠINSKE OBRADE

MKR MAT KROM

C CRNA



Artikl	Naziv
OH28107MKR	Vješalica 28107 mat krom
TH28107C	Vješalica 28107, Crna

POVRŠINSKE OBRADE

MKR MAT KROM

C CRNA

Profili Gola

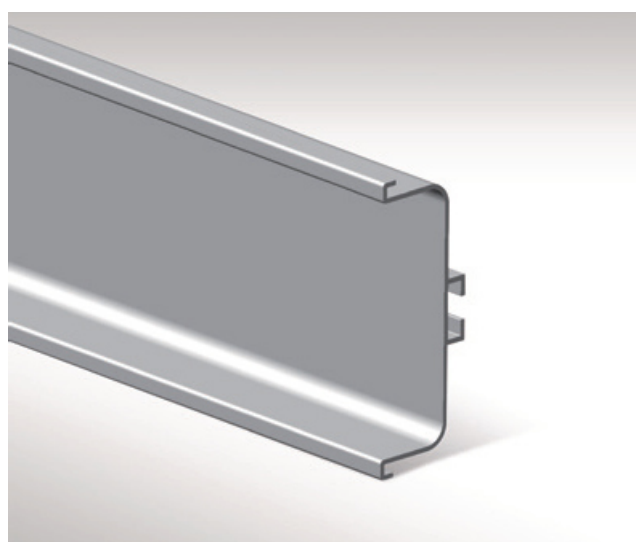
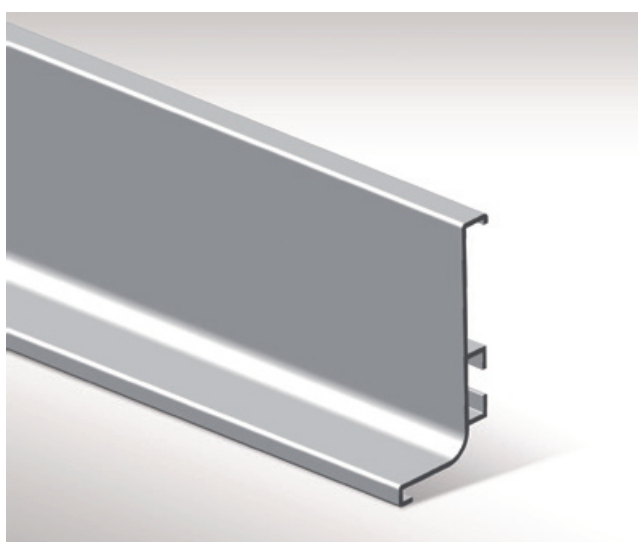

Gola profil L - 4,1 m

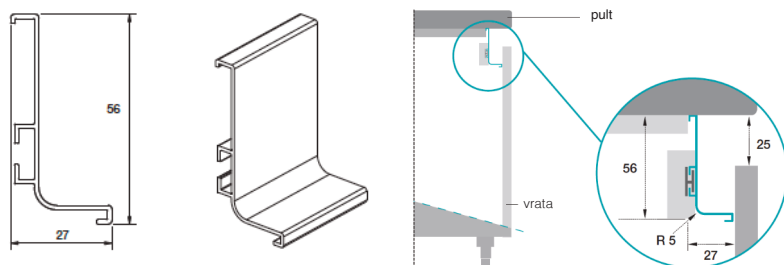

Artikl	Naziv	JM
OPGLPAL	Opes Gola profil L, ALU (4,1 tm)	TM
OPGLPB	Opes Gola profil L, BIJELO (4,1 tm)	TM
OPGLPC	Opes Gola profil L, CRNI (4,1 m)	TM
OPGLPANT	Opes Gola profil L, ANTRACIT (4,1 tm)	TM
OPGLPZL	Opes Gola profil L, ZLATNI (4,1 tm)	TM

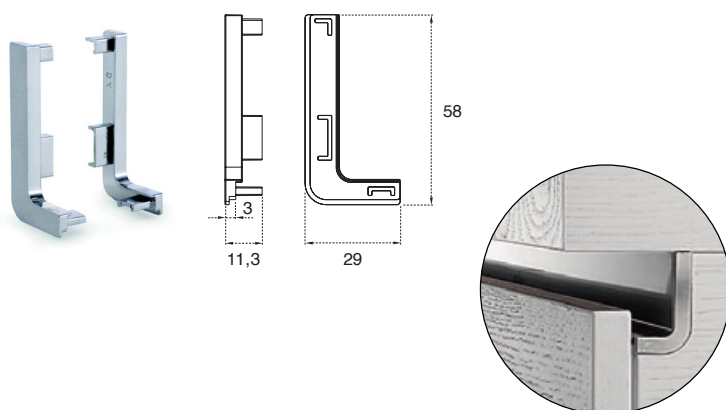

Artikl	Naziv	JM
OPGLZ	Završetak za GOLA L (L+D) - ALU	KPL
OPGLZB	Završetak za GOLA L (L+D) - BIJELO	KPL
OPGLZC	Završetak za GOLA L (L+D) - CRNI	KPL
OPGLZANT	Set završetaka za GOLA L (L+D) - ANTRACIT	KPL
OPGLZZL	Završetak za GOLA L (L+D) - ZLATNI	KPL

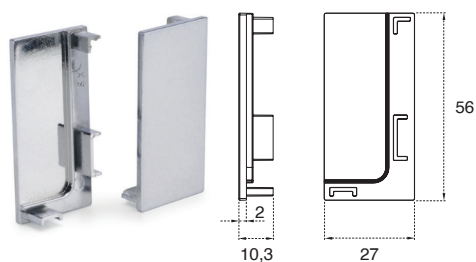

Artikl	Naziv	JM
OPGLZBP	Završetak za GOLA L (L+D) - BIJELO, PUNI	KPL
OPGLZCP	Završetak za GOLA L (L+D) - CRNI, PUNI	KPL
OPGLZP	Završetak za GOLA L (L+D) - PUNI	KPL
OPGLZANTP	Set završetaka za GOLA L (L+D) - ANTRACIT, PUNI	KPL
OPGLZZLP	Završetak za GOLA L (L+D) - ZLATNI, PUNI	KPL

Profili Gola

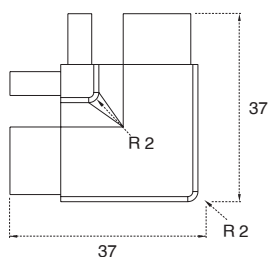

Artikl	Naziv	JM
OPGLKV	Kutnik za GOLA L, vanjski, ALU	KOM
OPGLKVC	Kutnik za GOLA L, vanjski, CRNI	KOM
OPGLKVB	Kutnik za GOLA L, vanjski, BIJELI	KOM

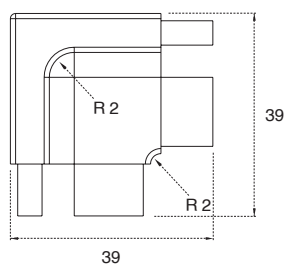

Artikl	Naziv	JM
OPGLKU	Kutnik za GOLA L, unutarnji, ALU	KOM
OPGLKUC	Kutnik za GOLA L, unutarnji, CRNI	KOM
OPGLKUB	Kutnik za GOLA L, unutarnji, BIJELI	KOM

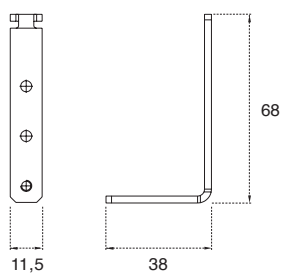
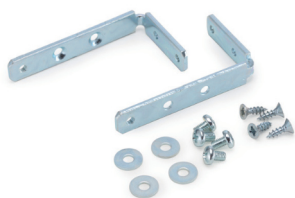

Artikl	Naziv	JM
OPGPK	Kutnik metalni - pričvršćivač Gola profila	KPL

Gola profil C 4,1m

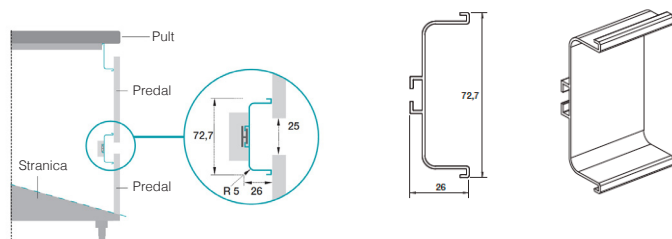

Artikl	Naziv	JM
OPGCPAL	Opes Gola profil C, ALU (4,1 tm)	TM
OPGCPB	Opes Gola profil C, BIJELA (4,1 tm)	TM
OPGCPC	Opes Gola profil C, CRNI (4,1 m)	TM
OPGCPANT	Opes Gola profil C, ANTRACIT (4,1 tm)	TM
OPGCPZL	Opes Gola profil C, ZLATNI (4,1 tm)	TM

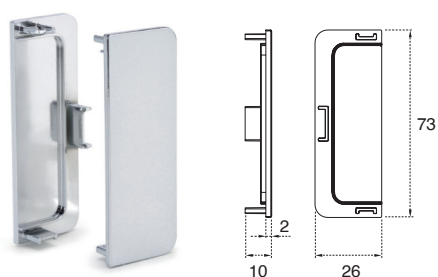

Artikl	Naziv	JM
OPGCZP	Završetak za GOLA C (univerzalni) - ALU, PUNI	KOM
OPGCZBP	Završetak za GOLA C (univerzalni) - BIJELI, PUNI	KOM
OPGCZCP	Završetak za GOLA C (univerzalni) - CRNI, PUNI	KOM
OPGCZANTP	Završetak za GOLA C (univerzalni) - ANTRACIT, PUNI	KOM
OPGCZZLP	Završetak za GOLA C (univerzalni) - ZLATNI, PUNI	KOM

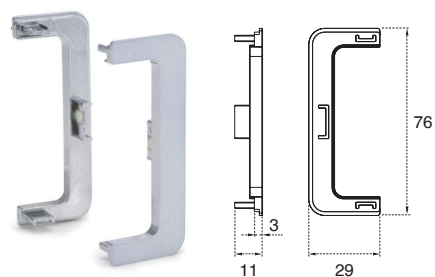

Artikl	Naziv	JM
OPGCZ	Završetak za GOLA C (univerzalni) - ALU	KOM
OPGCZB	Završetak za GOLA C (univerzalni) - BIJELI	KOM
OPGCZC	Završetak za GOLA C (univerzalni) - CRNI	KOM
OPGCZANT	Završetak za GOLA C (univerzalni) - ANTRACIT	KOM
OPGCZZL	Završetak za GOLA C (univerzalni) - ZLATNI	KOM

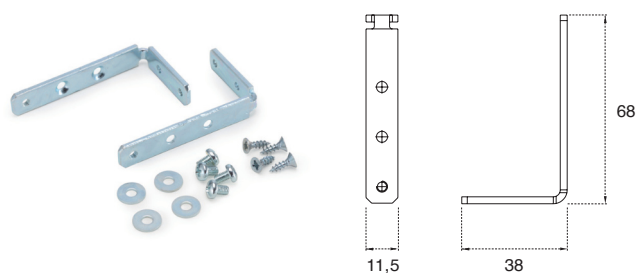

Artikl	Naziv	JM
OPGPK	Kutnik metalni - pričvršćivač Gola profila	KPL

Profili Gola

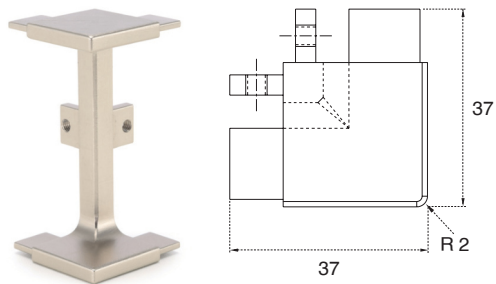

Artikl	Naziv	JM
OPGCKV	Kutnik za GOLA C, vanjski, ALU	KOM
OPGCKVC	Kutnik za GOLA C, vanjski, CRNI	KOM
OPGCKVB	Kutnik za GOLA C, vanjski, BIJELI	KOM

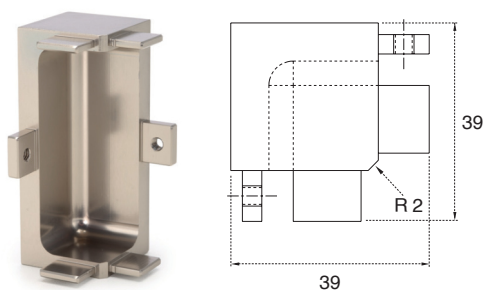

Artikl	Naziv	JM
OPGCKU	Kutnik za GOLA C, unutarnji, ALU	KOM
OPGCKUC	Kutnik za GOLA C, unutarnji, CRNI	KOM
OPGCKUB	Kutnik za GOLA C, unutarnji, BIJELI	KOM



Gola profil za zgornje elemente 4m

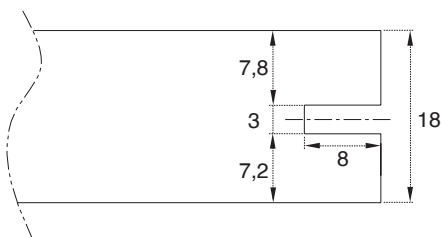
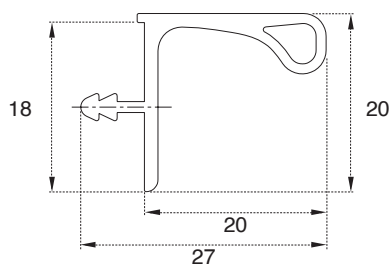

27

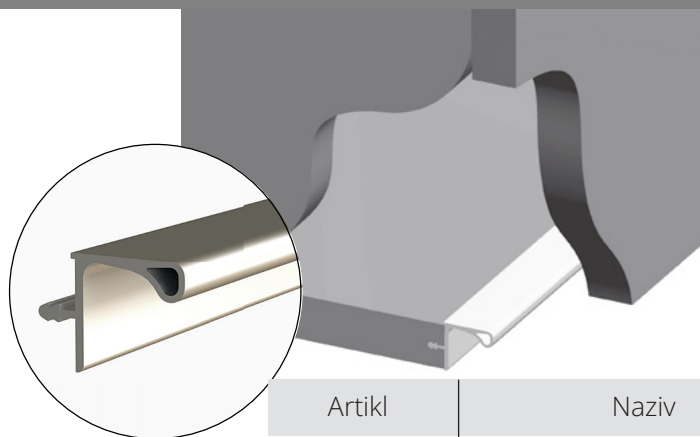

Artikl	Naziv	JM
GOAL268	Opes Gola profil za gornje elemente, ALU (4 m)	TM
GOAL268B	Opes Gola profil za gornje elemente, ALU (4 m), BIJELI	TM
GOAL268ANT	Opes Gola profil za gornje elemente, ANTRACIT-aluminij (4 m)	TM
GOAL268C	Opes Gola profil za gornje elemente, CRNI-aluminij (4 m)	TM
GOAL268ZL	Opes Gola profil za gornje elemente, ALU (4 m), ZLATNI	TM

Gola profil L vertikalni 4,5m

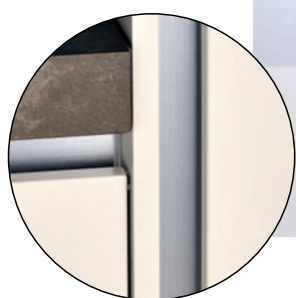
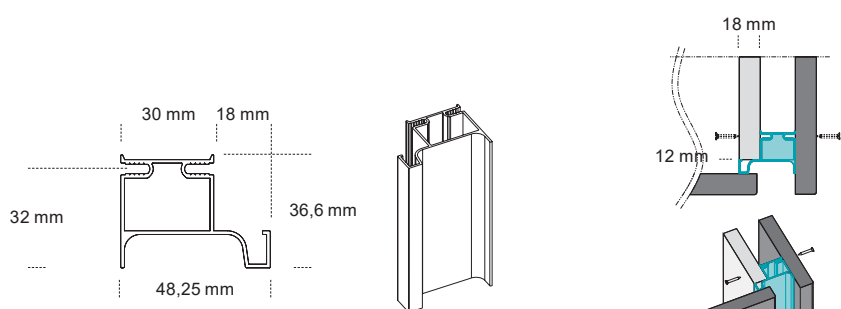

Artikl	Naziv	JM
OPGVLPAL	Opes Gola vertikalni profil L, ALU (4,5 tm)	TM
OPGVLPB	Opes Gola vertikalni L profil ALU, 4,5tm BIJELO	TM
OPGVLPC	Opes Gola vertikalni L profil ALU, 4,5tm CRNI	TM
OPGVLPANT	Opes Gola vertikalni L profil ALU, 4,5tm ANTRACIT	TM
OPGVLPAL27	Opes Gola vertikalni L profil, ALU 2,7tm	TM
OPGVLPB27	Opes Gola vertikalni L profil ALU, 2,7tm BIJELO	TM
OPGVLPC27	Opes Gola vertikalni L profil ALU, 2,7tm CRNI	TM
OPGVLPZL27	Opes Gola vertikalni L profil ALU, 2,7tm ZLATNI	TM

Gola profil C vertikalni 4,5m

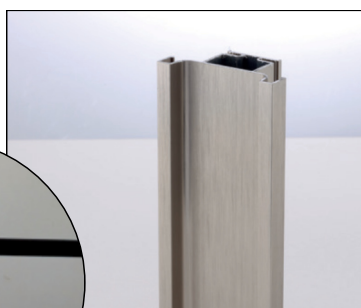
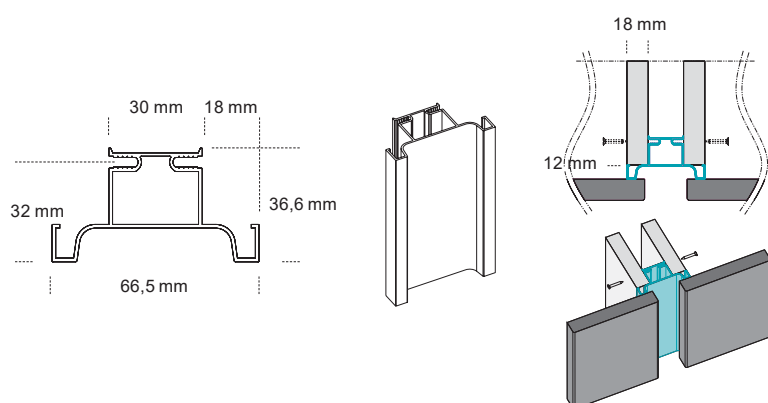

Artikl	Naziv	JM
OPGVCPAL	Opes Gola vertikalni profil C, ALU (4,5 tm)	TM
OPGVCPB	Opes Gola vertikalni C profil ALU, 4,5tm, BIJELO	TM
OPGV CPC	Opes Gola vertikalni C profil ALU, 4,5tm, CRNI	TM
OPGVCPANT	Opes Gola vertikalni profil C, ALU, 4,5 tm, ANTRACIT	TM
OPGVCPAL27	Opes Gola verikalni C profil, ALU, 2,7tm	TM
OPGVCPB27	Opes Gola vertikalni C profil ALU, 2,7tm, BIJELO	TM
OPGV CPC27	Opes Gola vertikalni C profil ALU, 2,7tm, CRNI	TM
OPGVCPZL27	Opes Gola vertikalni C profil ALU, 2,7tm, ZLATNI	TM

Profili Gola LED po narudžbi

Led Gola C profil 4,1m

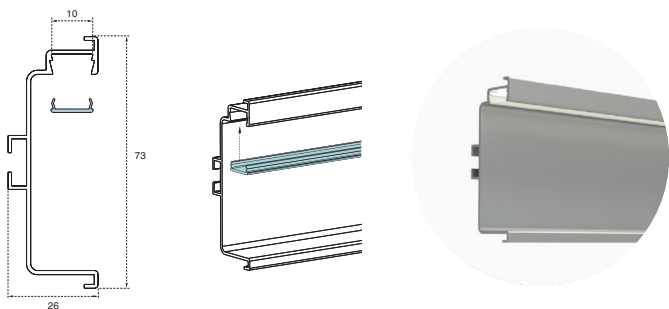

Artikl	Naziv	JM
GOLEDCPAL	Gola Opes LED C profil ALU l=4,1m	KOM
GOLEDCPC	Gola Opes LED C profil l=4,1m; CRNI	KOM

***dobavljivo po narudžbi**

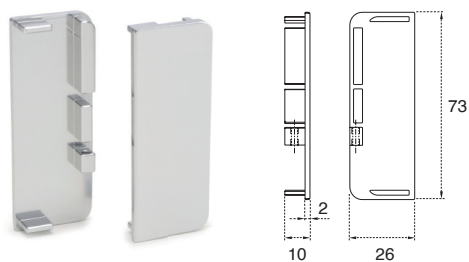

Artikl	Naziv	JM
GOLEDCZS	Opes LED Gola C profil - završetak sivi, tip 996	KOM
GOLEDCZC	Opes LED Gola C profil - završetak crni, tip 996	KOM

***dobavljivo po narudžbi**

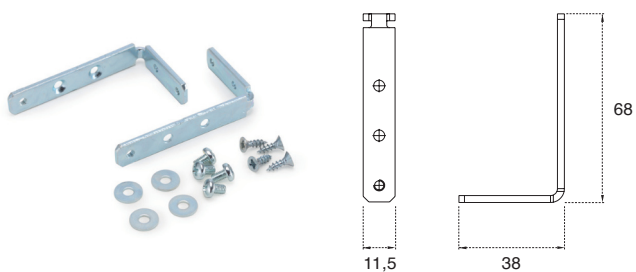

Artikl	Naziv	JM
OPGPK	Kutnik metalni - pričvršćivač Gola profila	KPL



Gola profil L 4,1m

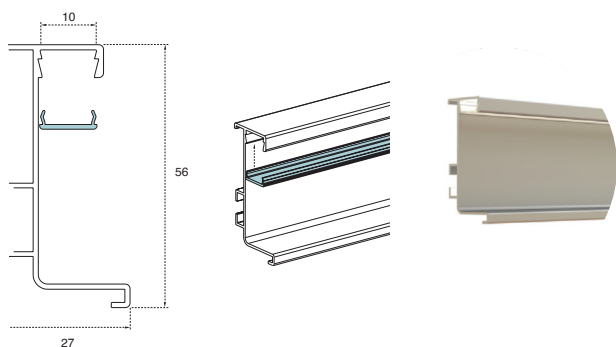

Artikl	Naziv	JM
GOEDLPAL	Gola Opes LED C profil ALU l=4,1m	KOM
GOEDLPC	Gola Opes LED C profil l=4,1m; barva ČRNA	KOM

***dobavljivo po narudžbi**

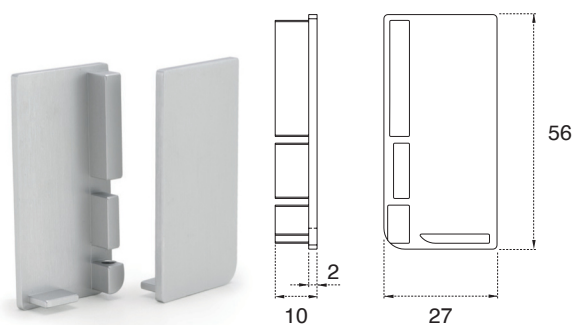

Artikl	Naziv	JM
GOEDLZS	Opes LED Gola L profil - završetak sivi, tip 995	KPL
GOEDLZC	Opes LED Gola L profil - završetak crni, tip 995	KPL

***dobavljivo po narudžbi**

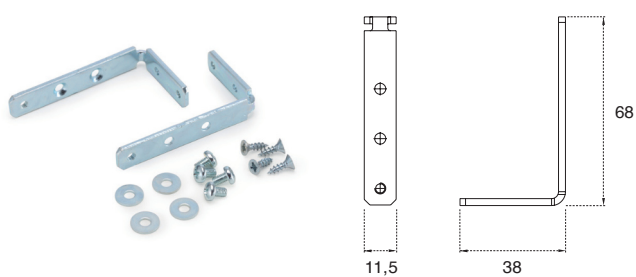

Artikl	Naziv	JM
OPGPK	Kutnik metalni - pričvršćivač Gola profila	KPL



Profili Gola LED po narudžbi

LED Gola vertikalni profil C 4,5m

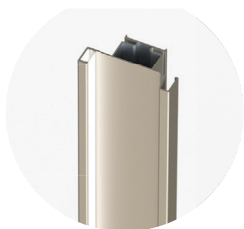
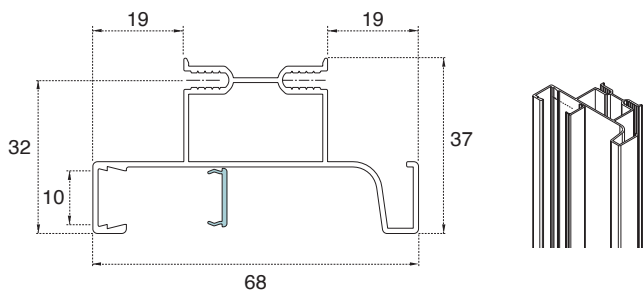

Artikl	Naziv	JM
GOLEDVCPAL	Gola Opes LED VERTIKALNI C profil ALU	KOM
GOLEDVCP	Gola Opes LED VERTIKALNI C profil CRNI	KOM
GOLEDVCPB	Gola Opes LED VERTIKALNI C profil BIJELE	KOM

***dobavljivo po narudžbi**

LED Gola vertikalni profil L 4,5m

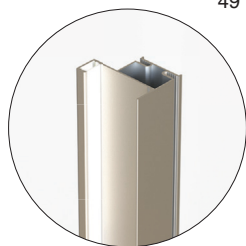
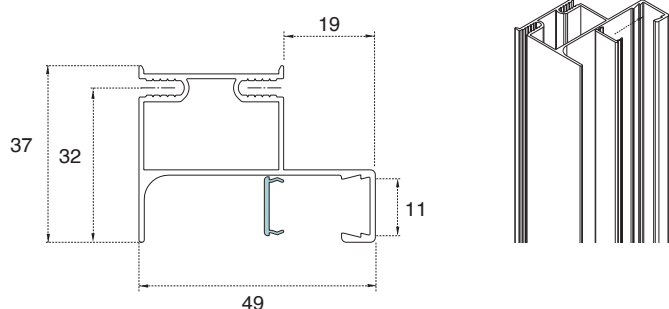

Artikl	Naziv	JM
GOLEDVLPAL	Gola Opes LED VERTIKALNI L profil ALU	KOM
GOLEDVLPAC	Gola Opes LED VERTIKALNI L profil CRNI	KOM
GOLEDVLPALB	Gola Opes LED VERTIKALNI L profil BIJELE	KOM

***dobavljivo po narudžbi**

LED Gola profil 270 4m

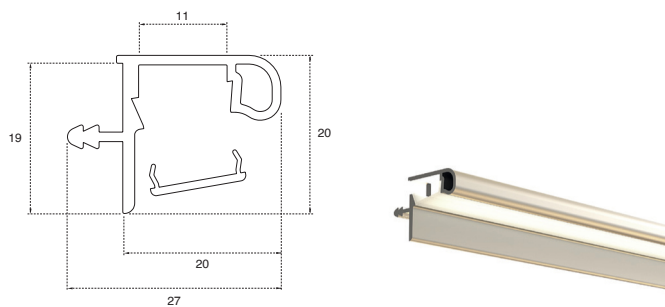

Artikl	Naziv	JM
GOLEDALP270	Gola Opes LED ALU Profil 270 L= 4m	KOM
GOLEDPC270	Gola Opes LED CRNI Profil 270 L= 4m	KOM
GOLEDBP270	Gola Opes LED BIJELE Profil 270 L= 4m	KOM

***dobavljivo po narudžbi**



Ručke po narudžbi

mital



Artikl					
RM3960	205	160	29	9	25
	330	288	29	9	10

POVRŠINSKE OBRADJE

- ECN** ECO NIKL
- MB** MAT BIJELA
- MC** MAT CRNA
- SN** SATEN NIKL

*dobavljivo po narudžbi

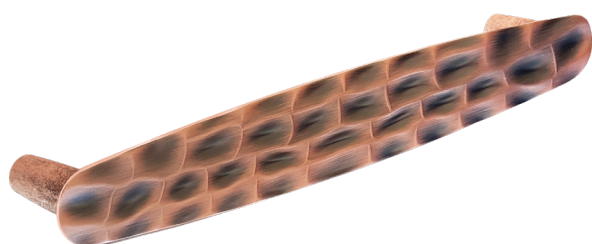

Artikl					
RM3470	180	160	26	25	25

POVRŠINSKE OBRADJE

- SBK** SATEN BAKER
- SJ** SATEN ČELIK

*dobavljivo po narudžbi



Artikl					
RM125	25	-	22	35	25

POVRŠINSKE OBRADJE

- ECN** ECO NIKL
- SN** SATEN NIKL
- KR** KROM

*dobavljivo po narudžbi



Artikl			
RM123	16	25	25

POVRŠINSKE OBRADJE

SS SATEN ČETKAN

***dobavljivo po narudžbi**



Artikl					
RM220	24	-	24	24	25

POVRŠINSKE OBRADJE

ANT ANTRACIT

KR KROM

SN SATEN NIKL

MKR MAT KROM

***dobavljivo po narudžbi**



Artikl					
RM330	20	-	20	20	25

POVRŠINSKE OBRADJE

KR KROM

MKR MAT KROM

MB MAT BIJELA

MC MAT CRNA

SN SATEN NIKL

***dobavljivo po narudžbi**



Artikl					
OM1950	93	-	76	42	12

POVRŠINSKE OBRADJE

- KR** KROM
- MC** MAT CRNA
- SN** SATEN NIKL

***dobavljivo po narudžbi**



Artikl					
OM412	49	-	40	26	50

POVRŠINSKE OBRADJE

- ECN** ECO NIKL
- B** BIJELA
- C** CRNA
- KR** KROM
- MN** MAT NIKL

***dobavljivo po narudžbi**



Artikl					
OM1400	91	-	18	47	12

POVRŠINSKE OBRADJE

- ANT** ANTRACIT
- KR** KROM
- SN** SATEN NIKL

***dobavljivo po narudžbi**



Artikl					
OM1405	64	-	65	38	12

POVRŠINSKE OBRADJE

- KR** KROM
- MB** MAT BIJELA
- SKR** SATEN KROM

***dobavljivo po narudžbi**



Artikl					
OM1150	95	-	70	50	12

POVRŠINSKE OBRADJE

- ECN** ECO NIKL
- SKR** SATEN KROM
- MC** MAT CRNA
- SN** SATEN NIKL
- KR** KROM

***dobavljivo po narudžbi**



Artikl					
OM1130	84	-	45	43	12

POVRŠINSKE OBRADJE

- KR** KROM
- SKR** SATEN KROM
- SN** SATEN NIKL

***dobavljivo po narudžbi**

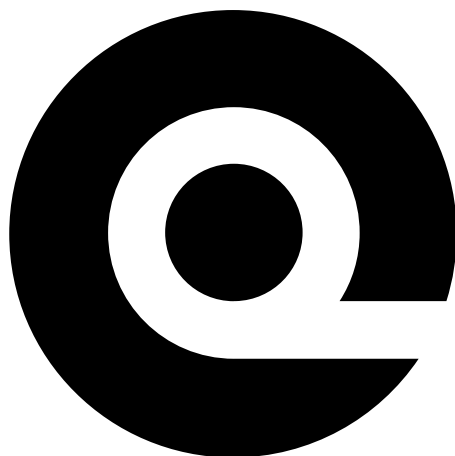

www.blazic.eu
info@blazic.hr

Blažič d.o.o.
Javorska 2, Novaki
10431 Sveta Nedelja

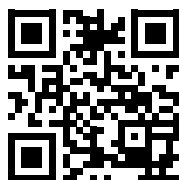

uvijek najnoviji katalogi

Blažič d.o.o., Javorska 2, Novaki, 10431 Sveta Nedelja, t: 01 / 6550 717 e: info@blazic.hr
Blažič d.o.o., Poslovnica Split, Alkarska 1, 21000 Split, t: 021 / 326 217 e: ante.javorcic@blazic.hr